



Outdoor Gigabit Ethernet PoE Switch

Quick Installation Guide

P/N: A625014200G

Model	Description
H40-044-30-150-V3	4xGbE 30W PoE + 2xGbE RJ45 + 2xGbE SFP w/100-240VAC input
H40-044-91-250-V3	4xGbE 90W bt PoE + 2xGbE RJ45 + 2xGbE SFP w/100-240VAC input
H40-082-30-250-V3	8xGbE 30W PoE + 2xGbE SFP w/100-240VAC input

Model	Description
H40-044-30-DC	4xGbE 30W PoE + 2xGbE RJ45 + 2xGbE SFP w/12-56VDC input
H40-044-91-DC	4xGbE 90W bt PoE + 2xGbE RJ45 + 2xGbE SFP w/12-56VDC input
H40-082-30-DC	8xGbE 30W PoE + 2xGbE SFP w/12-56VDC input

PACKAGE CONTENTS

* 1x PoE switch	* 1x Quick Installation Guide
* 1x T25 L-wrench, 4x wall anchors	

⚠ IMPORTANT:

1. Install the PoE switch in a ventilated and dry place that is free of electromagnetic source, vibration, moisture, and dust.
2. Make sure the ventilation openings on the switch are not blocked.
3. Use CAT5 or 5e UTP/STP cables.
4. AC input (100~240V/AC, 50~60Hz) or DC input (12~56VDC)
5. Although housing is IP67 rating, this is not suitable for water jets.

6. The cabinet must be grounded using a ground wire between the ground screw and earth ground.

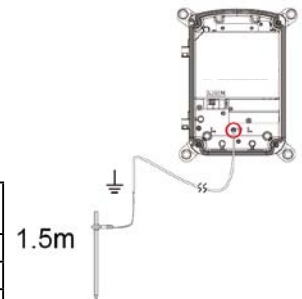

LED DEFINITIONS

Power PW1/PW2	Green ON	Power is on and normal.
SFP port Green	Green ON	Fiber is aeeached.
	Green Flashing	Data is being transmitted / received.
LAN ports Green	Green ON	TX link is detected.
	Green Flashing	Data is being transmitted or received.
PoE ports Amber	Amber ON	PSE is activated and PD is detected.
	Amber OFF	PoE OFF

RESET

Reset the switch	3 seconds	Blinking Green	All LEDs off
------------------	-----------	----------------	--------------

H40-044-30-150-V3 / H40-044-91-250-V3

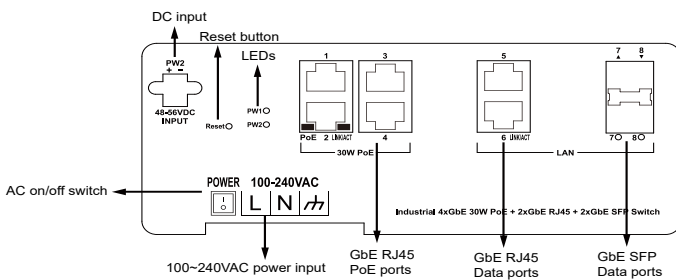

H40-082-30-250-V3

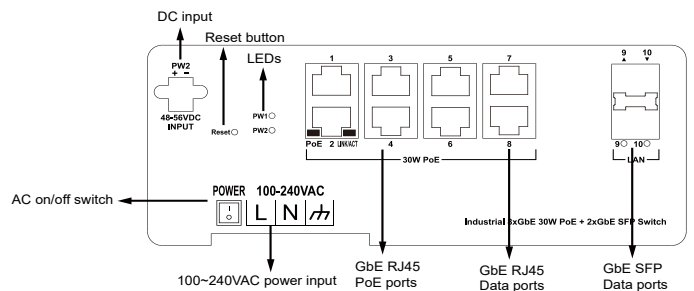

H40-044-30-DC / H40-044-91-DC

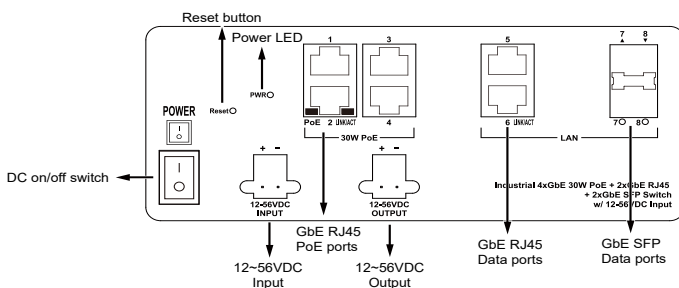

H40-082-30-DC

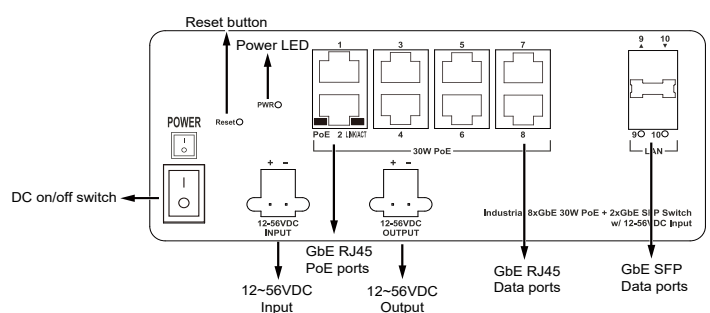

INSTALLATION

Use the included M8 hex socket screws to secure the Outdoor PoE Switch to a pole-mount or corner mount bracket.

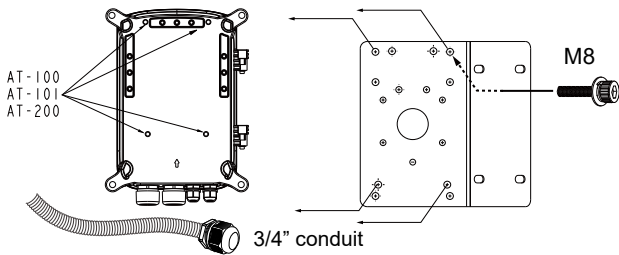

The mounting hole definition is illustrated below. The same mounting hole pattern apply to all pole-mount and corner-mount brackets.

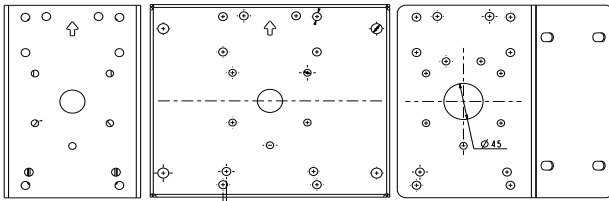

AC Power Cable Spec.

Wire Size	10~18AWG
Wire Strip Length	8mm

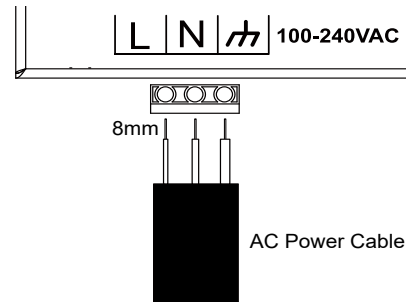

DC Power Cable Spec.

Wire Size	10~18AWG
Wire Strip Length	8mm

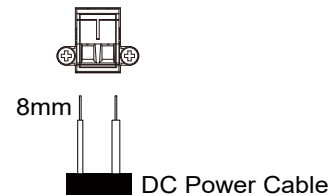

ASSEMBLE CABLE GLANDS

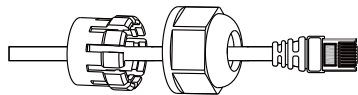
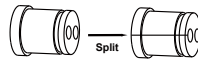
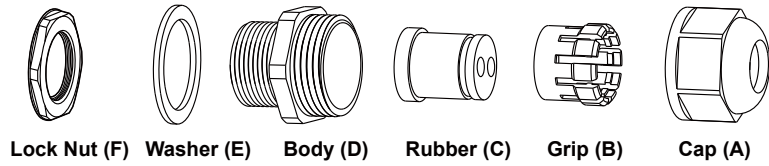

1. Thread the Cat5e/6 cable through the cap(A) & grip(B)

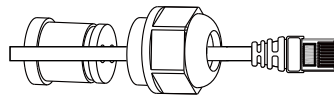

2. Split rubber(C), rubber have one sizes for meet 4.5~6.5mm Cat5e/6 cable.

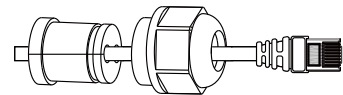

3. Fit the split rubber(C) over the Cat5e/6 cable

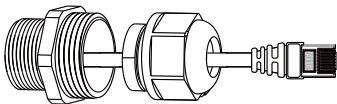

4. Thread the Cat5e/6 cable through the body(D)

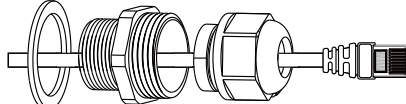

5. Assemble the washer to the body.

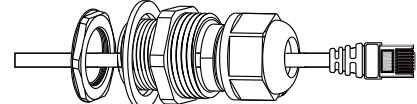

6. Mount the nut to the assemblage.

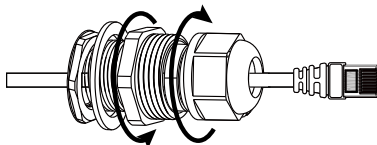

7. Tighten the cap and the body together as the illustration shows.

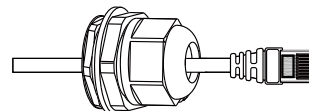

8. Tighten the whole assemblage to the full. See the illustration.

All specifications are subject to change without notice.
Copyright © 2023 AETEK INC. All rights reserved.

AETEK INC.
6F, No.192-1, Lien-Cheng Rd., Chung-Ho, New Taipei City, 235, Taiwan, R.O.C.
| T: +886-2-82452822 | W: www.aetektec.com | E: sales@aetektec.com